





# BEAUBIEN ATELIER 01



Guided by the images of a waterfall and a weeping willow, the Beaubien Atelier 01 provides a vertical focal point that elevates the room it lives in.

When viewed from afar, its delicate rose hue seems to change before our very eyes, as if the light itself was warming up; the elusive nature of the Beaubien Atelier 01 creates a dreamlike, meditative atmosphere, both comforting and striking.

<b>TYPE</b>	Suspension
<b>CONSTRUCTION</b>	Powder coated aluminum and brass body Frosted milk glass tube
<b>SPECIFICATIONS</b>	Source: LED lamp provided (G9 base) Power consumption: 8 × 2.5W Lumen output: 2400lm  Colour temperature: 2700K included * 3000K available upon request Colour rendering index: ≥ 90 CRI standard Expected lifetime: 25 000h
<b>CONTROL</b>	Refer to our recommended list of dimmer models
<b>TOTAL HEIGHT</b>	Custom
<b>WEIGHT</b>	Min. 7.5 lb / 3.4 Kg
<b>CERTIFICATIONS</b>	     IP20
<b>WARRANTY</b>	2 years

## NOTES

- Luminaire total height (ceiling to lowest point of luminaire)  
Min - 69" / 175 cm  
Max - variable, please specify
- Luminaire height is not adjustable on site
- For slanted ceiling, contact Lambert & Fils
- Dimensions are approximate and may vary slightly

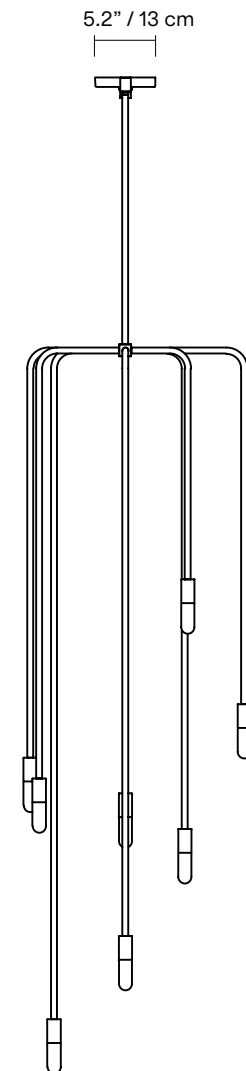
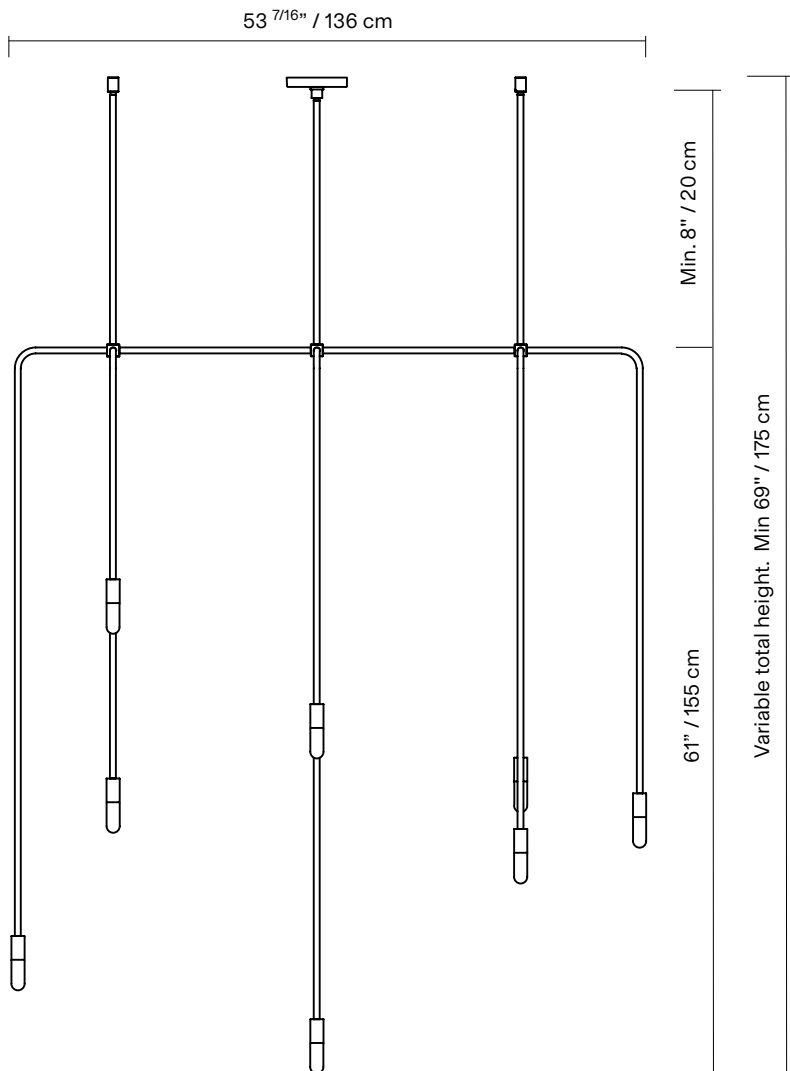
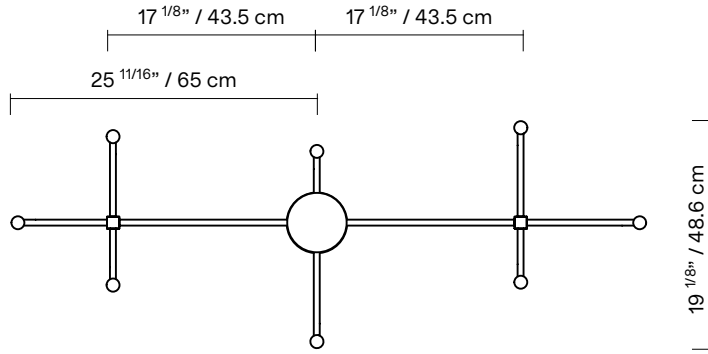

## FINISH



**DP**  
Wrinkled  
dusty pink

## NOTES

- Must be installed by an electrician
- Not protected against liquids (refer to IP20)
- Additional charges for modifications or for special orders
- Please refer to maintenance sheet on our website for cleaning instructions

## LAMP ANATOMY

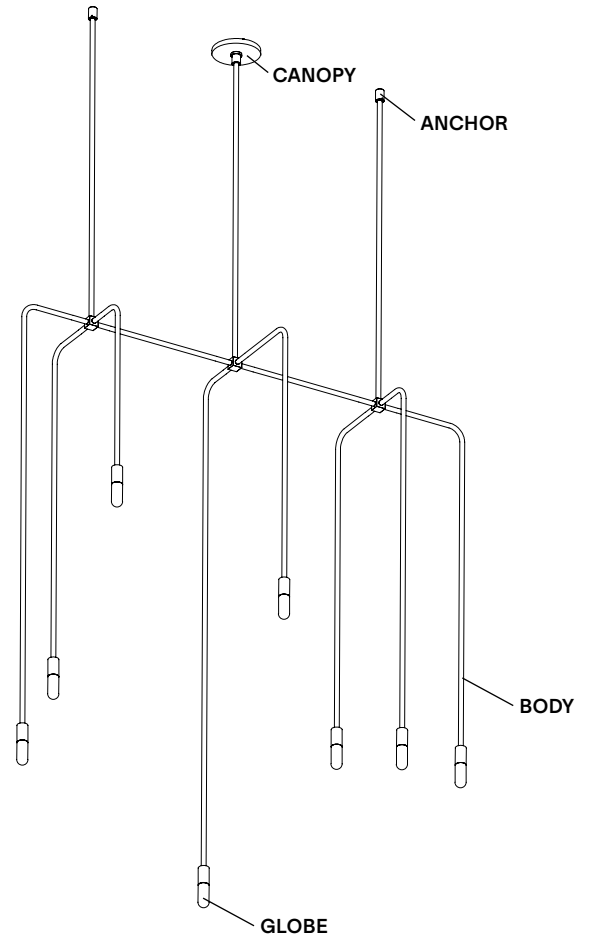

## TESTED DIMMER COMPATIBILITY LIST - 120V\*

Phase cut dimming (leading edge or trailing edge\*\*)

DIMMER BRAND	MODEL	MAX LEVEL	MIN LEVEL	DIMMING PROTOCOL
LUTRON - MAESTRO	MAELV-600	100%	0%	Phase Cut
LUTRON - SKYLARK	SELV-300P	100%	0%	Phase Cut
LUTRON - SKYLARK	SELV-300P	100%	0%	Phase Cut
LUTRON - SKYLARK	CTELV-303P	100%	0%	Phase Cut
LUTRON - DIVA	DVELV-300P	100%	0%	Phase Cut
LEGRAND - ADORNE	TRUE UNIVERSAL	100%	30%	Phase Cut

## TESTED DIMMER COMPATIBILITY LIST - 230V\*

Phase cut dimming (leading edge or trailing edge\*\*)

DIMMER BRAND	MODEL	MAX LEVEL	MIN LEVEL	DIMMING PROTOCOL
VARILIGHT	V-PRO	100%	2%	Phase Cut
LEGRAND - NILOÉ	3 996 35	87%	15%	Phase Cut
NIKO	310-0280X	94%	5%	Phase Cut
NIKO	310-0190X	100%	1%	Phase Cut

\*Other dimmers can yield good results and we recommend conducting your own test before final installation.

---

Some dimmers require a minimum load, check specifications.

---

\*Other dimmers that specify LED lamp compatibility may operate without issue.

---

We recommend conducting your own test before final installation.

---

\*\*Leading edge is also known as TRIAC or Forward Phase.

---

Trailing edge is also known as ELV or Reverse Phase.

---